

## Photochemistry

**1.1 Introduction:-** Photochemistry is concerned with reactions which are initiated by electronically excited molecules. Such molecules are produced by the absorption of suitable radiation in the visible and near ultraviolet region of the spectrum. Photochemistry is basic to the world we live in with sun as the central figure, the origin of life must have been a photochemical act. Simple gaseous molecules like methane, ammonia and carbon dioxide must have reacted photochemically to synthesize complex organic molecules like proteins and nucleic acids. Photobiology, the photochemistry of biological reactions, is a rapidly developing subject and helps in understanding the phenomenon of photosynthesis, phototaxis, photoperiodism, vision and mutagenic effects of light.

The relevance of photochemistry also lies in its varied applications in science and technology. Synthetic organic photochemistry has provided methods for the manufacture of many chemicals which could not be produced by dark reactions. Some industrially viable photochemical syntheses include synthesis of vitamin D<sub>2</sub> from ergosterol isolated from yeast, synthesis of caprolactam which is the monomer for Nylon 6, manufacture of cleaning solvents and synthesis of some antioxidants.

Photoinitiated polymerization and photopolymerisation are used in photography, lithoprinting and manufacture of printed circuits for the electronic industry.

The photophysical phenomena of fluorescence and phosphorescence have found varied applications in fluorescent tube

lights, TV screens, as luminescent dials for watches, as “optical brighteners” in white dress materials, as paints in advertisement hoardings and so on. Another revolutionary application of electronically excited molecular systems is laser technology.

The two main processes, therefore, studied under photochemistry are:

1. Photophysical process
  2. Photochemical process
1. **Photophysical process:-** In this process, the absorption of light does not result into any chemical reaction.
  2. **Photochemical process:-** In this process, the light that is absorbed by a system results into chemical change.

### **1.2 Difference between thermal and photochemical reactions:**

The main points of difference between thermal and photochemical reactions are as under:

<b>Thermal Reactions</b>	<b>Photochemical Reactions</b>
1. These reactions involve the absorption of heat	1. These reactions involve absorption of quantum of radiation. (UV/visible)
2. Temperature has significant effect on the rate of a thermal reaction.	2. Temperature has very little effect on the rate of a photochemical reaction. Instead intensity of light has a marked effect on the rate of a photochemical reaction.
3. In these reactions, activation energy arises from the intermolecular collisions or it is supplied in the form of heat.	3. In these reactions, activation energy is acquired by absorption of quanta of radiation of suitable energy.

<p>4. When a reaction mixture is exposed to heat radiation, all the reactant molecules absorb these radiations and get excited almost to the same extent i.e., there is no selectivity.</p> <p>5. All the thermal reactions are accompanied by a decrease in free energy i.e. <math>\Delta G</math> is always negative.</p> <p>6. The presence of light is not necessary for the reaction to take place and can take place even in the dark.</p>	<p>4. When a reaction mixture is exposed to light radiation, the molecules of a single selected species can be promoted to an excited state independent of the other species present in the mixture.</p> <p>5. There are various photochemical reactions such as photosynthesis of carbohydrates through chlorophyll and sunlight, polymerisation of anthracene, decomposition of ammonia etc. which are accompanied by increase in free energy.</p> <p>6. The presence of light is an essential requirement for the reaction to take place.</p>
--	--

### **1.3 Interaction between radiation and matter:**

The knowledge of the physical world is based on the interaction between electromagnetic radiation and matter, because to understand matter we have to make use of radiation and to understand radiation we must involve matter. For example, x-rays are used to elucidate the structure of molecules in their crystalline state, and take the help of various types of spectroscopic methods for the understanding of the intricate architecture of atoms and molecules. On the other hand, if nature of electromagnetic radiation is to be studied, it is allowed to fall on matter which reflects, transmits, scatters or absorbs in order to understand its behaviour. All measuring devices are based on such

interactions. In some of these interactions, electromagnetic radiation behaves as a particle and in some cases as a wave.

When electromagnetic radiation falls on an atom or a molecule, the electric field of the radiation tends to disturb the charge cloud around the atom or the molecule. The situation is analogous to the case when a particle composed of positive and negative charges is brought near an electric field. When the field is applied from the upper side (Figure), the positive charge density is attracted towards it and the negative charge density repelled, generating a dipole moment in the particle. If now the field is applied from the lower side, the direction of the dipole is reversed. If the field oscillates between the upper and the lower positions, the induced dipole will also oscillate with the frequency of oscillation of the field.

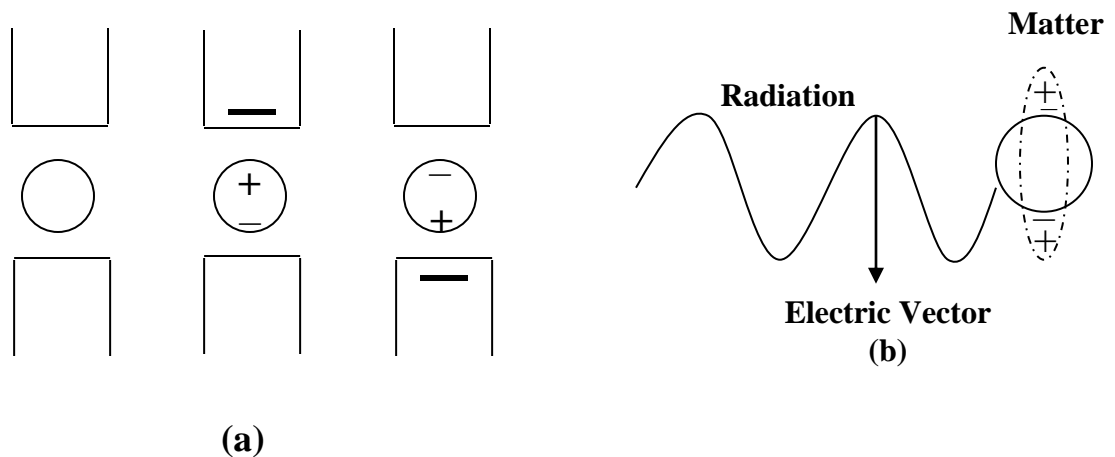

**Figure:** *creation of an oscillating dipole by interaction between the charge cloud of an atom, (a) an oscillating electric field (b) electromagnetic radiation wave.*

The oscillating electric field of the electromagnetic radiation acts in a similar manner to create an oscillating dipole in the atom or the

molecule with which it is interacting. The dipole is generated in the direction of the electric vector of the incident radiation.

From electrodynamics, we know that when a positive and a negative charge oscillate with respect to each other, it becomes a source of electromagnetic radiation. The disturbed molecule becomes a source of electromagnetic radiation of the same frequency as the frequency of the incident radiation. This is the mechanism of radiation by a particle of molecular dimensions. The secondary radiation thus scattered uniformly in all directions interferes with the primary incident radiation. As a result, radiation waves are cancelled out by destructive interference in all directions except that of reflection or refraction.

As long as the frequency of the incident radiation  $V_i$  is not close to that of the natural frequency  $V_n$  of the molecule as given by its energy states, the oscillations are due to forced distribution of the molecule by the electromagnetic wave. But when  $V_i \approx V_n$ , and a resonance condition is established between the two interacting partners (the photon and the molecule), the oscillations classically become free. Under this condition, a quantum of radiation or photon is absorbed by the atom or the molecule, promoting it to a higher energy state.

#### **1.4 Laws of absorption:**

When a beam of monochromatic light is allowed to pass through an absorbing medium, a part of the incident light is reflected, a part is absorbed by the medium and the rest is transmitted. If  $I_o$  is the intensity of incident light,  $I_r$ , the intensity of reflected light,  $I_a$  the intensity of light absorbed and  $I_t$  the intensity of transmitted light then

$$I_o = I_r + I_a + I_t$$

However, by using a comparison cell,  $I_r$  is very small (about 4%) and can be neglected for air-glass interfaces. Then,

$$I_o = I_a + I_t$$

The decrease in intensity of light after passing through the medium is governed by two photophysical laws namely Lambert's law and Beer's law.

**1. Lambert's law:-** This law was put forward by Lambert in 1760 and is stated as under:

“When a beam of monochromatic light is passed through a homogeneous absorbing medium, the decrease in intensity of light with thickness of the absorbing medium is directly proportional to the intensity of the incident light.

Mathematically

$$\begin{aligned} & - \frac{dI}{dx} \propto I \\ \text{or} & - \frac{dI}{dx} = k \cdot I \quad \dots\dots\dots (1) \end{aligned}$$

where  $dI$  is the small decrease in intensity of light on passing through a small thickness  $dx$ ,  $I$  is the intensity of incident light just before entering the thickness  $dx$  and  $k$  is the constant of proportionality. The minus sign is introduced because there is reduction in intensity of light after passing through the medium. Eq. (1) can be rewritten as:

$$\begin{aligned} & - \frac{dI}{dx} = k \cdot I \\ \Rightarrow & - \frac{dI}{I} = k \cdot dx \quad \dots\dots\dots (2) \end{aligned}$$

If  $x$  is the total length of the medium (path length) and  $I_0$  is the intensity of incident light at  $x = 0$  then equation (2) can be integrated between the limits

$$\begin{aligned} & x = 0 ; \quad I = I_0 \\ \& \quad x = x; \quad I = I_t \end{aligned}$$

as under:

$$\int_{I = I_0}^{I = I_t} \frac{dI}{I} = -k \int_{x = 0}^{x = x} dx$$

$$\Rightarrow \left| \ln I \right|_{I = I_0}^{I = I_t} = -k \left| x \right|_{x = 0}^{x = x}$$

$$\Rightarrow \ln I_t - \ln I_0 = -k(x - 0)$$

$$\Rightarrow \ln (I_t / I_0) = -k \cdot x \quad \dots\dots\dots (3)$$

$$\Rightarrow (I_t / I_0) = e^{-k \cdot x}$$

$$\Rightarrow I_t = I_0 \cdot e^{-k \cdot x}$$

If  $I_{\text{abs.}}$  is the intensity of light absorbed, then

$$I_{\text{abs.}} = I_0 - I_t$$

$$\Rightarrow I_{\text{abs}} = I_0 - I_0 \cdot e^{-k \cdot x}$$

$$\Rightarrow I_{\text{abs}} = I_0 (1 - e^{-k \cdot x}) \quad \dots\dots\dots (4)$$

equation (3) can also be represented as

$$2.303 \log (I_0 / I_t) = k \cdot x$$

$$\Rightarrow \log \left( \frac{I_0}{I_t} \right) = k' \cdot x$$

where  $k' = k / 2.303$

$$\text{thus, } k' = \frac{1}{x} \cdot \log \left( \frac{I_0}{I_t} \right) \dots\dots\dots(5)$$

where  $k'$  is called absorption coefficient, absorptivity of the substance or extinction coefficient. Its value depends upon the nature of the absorbing medium and the wavelength of the light employed.

According to equation (5)

$$k' = \frac{1}{x} \cdot \log \left( \frac{I_0}{I_t} \right)$$

$$\text{If } \log \left( \frac{I_0}{I_t} \right) = 1; \text{ then } \log \left( \frac{I_0}{I_t} \right) = \log 10$$

$$\Rightarrow \frac{I_0}{I_t} = 10 \quad \Rightarrow \quad I_t = (1/10) \cdot I_0$$

$$\therefore k' = 1/x$$

Thus the extinction coefficient may be defined as the reciprocal of that thickness of the medium required to reduce the light to one-tenth of its intensity.

It may be noted that  $\log(I_0/I_t)$  is called absorbance of the medium and the ratio  $(I_t/I_0)$  is called as transmittance.

while absorbance is denoted by A, the transmittance is denoted by T.

$$\begin{aligned} \text{Thus, } \log \left( \frac{I_0}{I_t} \right) &= k' \cdot x \\ \Rightarrow \quad A &= k' \cdot x \end{aligned}$$

$$\text{and } T = (I_t/I_0) .$$

Absorbance (A) also called as optical density is related to transmittance by the following relation



$$A = \log ( \underline{1/T} )$$

$$\Rightarrow A = \log T^{-1} \Rightarrow A = -\log T \dots\dots\dots (6)$$

**Lambert – Beer law:**

When a beam of monochromatic radiation is passed through a solution, the decrease in intensity of light with thickness of the absorbing medium is directly proportional to the intensity of the incident radiation and also to the concentration “c” of the solution.

Mathematically

$$\begin{aligned}
 & - \frac{dI}{dx} \propto I \cdot C \\
 \Rightarrow & - \frac{dI}{dx} = \epsilon \cdot I \cdot C \\
 \Rightarrow & \frac{dI}{I} = - \epsilon \cdot C \cdot dx \dots\dots\dots(1)
 \end{aligned}$$

where  $\epsilon$  is a constant of proportionality. Integrating = n (1)

between the limits  $x = 0, I = I_0$  and  $x = x, I = I_t$

We get

$$\int_{I=I_0}^{I=I_t} \frac{dI}{I} = -\epsilon \cdot C \int_{x=0}^{x=x} dx$$

$$\Rightarrow \left| \ln I \right|_{I=I_0}^{I=I_t} = -\epsilon \cdot C \cdot \left| x \right|_{x=0}^{x=x}$$

$$\Rightarrow \ln (I_t / I_0) = -\epsilon \cdot C \cdot x \dots\dots\dots (2)$$

$$\Rightarrow I_t / I_0 = e^{-\epsilon \cdot C \cdot x}$$

$$\Rightarrow I_t = I_0 \cdot e^{-\epsilon \cdot C \cdot X}$$

The intensity of the light absorbed by the solution when it passes through a length “x” of the solution is given by.

$$\begin{aligned} I_{\text{abs}} &= I_0 - I_t = I_0 - I_0 \cdot e^{-\epsilon \cdot C \cdot X} \\ &= I_0 (1 - e^{-\epsilon \cdot C \cdot X}) \end{aligned}$$

Equation (2) can be written as

$$\begin{aligned} 2.303 \log \left( \frac{I_t}{I_0} \right) &= -\epsilon \cdot C \cdot X \\ \Rightarrow \log \left( \frac{I_t}{I_0} \right) &= -(\epsilon / 2.303) \cdot C \cdot X \\ \Rightarrow \log \left( \frac{I_t}{I_0} \right) &= -\epsilon' \cdot C \cdot X \\ \Rightarrow \log \left( \frac{I_0}{I_t} \right) &= \epsilon' \cdot C \cdot X \quad \dots\dots\dots(3) \end{aligned}$$

where  $\epsilon' = \epsilon / 2.303$  is called as molar absorption coefficient or molar absorptivity or molar extinction coefficient.

Since, 
$$A = \log \left( \frac{I_0}{I_t} \right)$$

Therefore, eq(3) can be written as

$$A = \epsilon' \cdot C \cdot X \quad \dots\dots\dots(4)$$

or 
$$\epsilon' = \frac{A}{CX} \Rightarrow \epsilon' = \frac{1}{CX} \cdot \log \left( \frac{I_0}{I_t} \right)$$

If  $C = 1 \text{ M}$  &  $\log \left( \frac{I_0}{I_t} \right) = 1$

Then  $\epsilon' = \frac{1}{X}$  ; we know  $\log \left( \frac{I_0}{I_t} \right) = 1$

means  $I_t = \frac{1}{10} I_0$

Thus molar extinction coefficient may be defined as the reciprocal of that thickness of the solution layer of 1 molar

concentration which reduces the intensity of the light passing through it to one-tenth of its original value.

Beer's law is thus an extension of Lambert's law applicable to solutions.

### Units of molar absorption Co efficient:-

$$\epsilon' = \frac{1}{Cx} \log \left( \frac{I_0}{I_t} \right)$$

If concentration is expressed in mol L<sup>-1</sup> and length x in cm

Then unit of  $\epsilon'$  is L mol<sup>-1</sup> cm<sup>-1</sup>

& if concentration is expressed in mol dm<sup>-3</sup> and x in m

Then unit of  $\epsilon'$  is dm<sup>3</sup> mol<sup>-1</sup> m<sup>-1</sup>.

The plot of absorbance "A" versus concentration "C" is a straight line passing through origin. The value of  $\epsilon'$  (molar extinction coefficient) can be obtained from the slope.

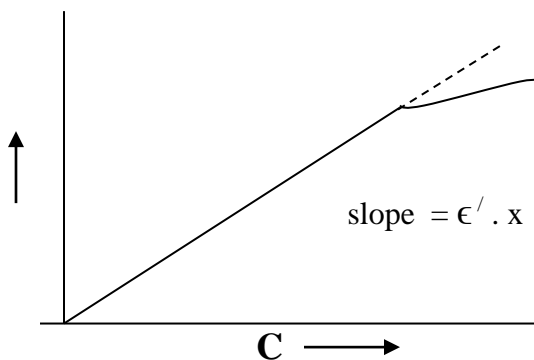

### **Limitations of Lambert – Beer law:-**

1. The law holds good only for monochromatic radiation.
2. The law governs the absorption behaviour of dilute solutions only. At higher solute concentration, the ions of a solute in case it is an electrolyte, are close enough to disturb the charge distribution of their

neighbours. The inter-ionic interaction drastically alters the ability of the solute to absorb a given wavelength of the incident radiation. Thus the relationship between A and C is no longer linear. At higher concentrations, the refractive index ( $\mu$ ) of the solution also changes and it has been found that it is the quantity  $[\mu / (\mu + 2)^2] \epsilon'$ , rather than  $\epsilon'$  which remains constant. Thus when  $[\mu / (\mu + 2)^2]$  changes with change in concentration, the law shows deviation.

3. The temperature of the system should not be allowed to vary to a large extent. Too much rise in temperature shifts the absorption bands towards longer wavelength (bathochromic effect).

*Example:- Calculate the transmittance, absorbance and molar extinction coefficient of a solution which transmits 10% of a certain wavelength of light beam passed through a 2 cm cell containing 0.5 molar solution.*

**Solution:**  $I_{\text{abs}} = 90\%$  of  $I_0$ ;  $X = 2\text{cm}$ ;  $C = 0.5 \text{ mol}^{-1}$

$$\therefore T = \frac{I_t}{I_0} = \frac{10\% I_0}{I_0} = \frac{10}{100} = 0.1$$

$$\therefore A = -\log T = -\log (0.1) = \log 10 = 1$$

$\therefore$  According to Lambert- Beer law

$$A = \epsilon' \cdot C \cdot X$$

$$\Rightarrow 1 = \epsilon' \cdot C \cdot X$$

$$\Rightarrow \epsilon' = \frac{1}{CX}$$

$$\Rightarrow \epsilon' = \frac{1}{0.5 \times 2} = \frac{1}{1} = 1 \text{ Lmol}^{-1} \text{ cm}^{-1}$$

## 1.5 Laws of photochemistry

There are two laws which govern the effect of radiation on chemical reactions. These laws are:

1. **Grotthus – Drapper law:-** This law was enunciated by Grotthus and Drapper in the 19<sup>th</sup> century. They found that all the light that was incident on a sample was not effective in bringing about a chemical change. According to this law, also called the principle of photochemical activation, only that part of the light which is absorbed by a system can bring about a chemical change.

The law, however, does not imply that the absorbed light must always bring about a chemical change. The absorbed light may sometimes result in fluorescence and phosphorescence and in some cases, it may be converted into heat. The law is purely qualitative in nature and doesn't give any relationship between the amount of light absorbed by a system and the number of reacting molecules.

2. **Stark-Einstein's law of Photochemical Equivalence:-** This law, also called the principle of quantum activation, was enunciated by Stark in 1908 and independently by Einstein in 1912. The two scientists applied the concept of energy quantum to photochemical reactions. According to this law, one molecule is activated by the absorption of one quantum of radiation in the primary or first step of a photochemical reaction. The law, however, does not imply that one molecule must react for each quantum of radiation absorbed.

If " $\nu$ " is the frequency of the radiation absorbed, then the corresponding quantum of energy absorbed per molecule will be

$h\nu$ , where  $h$  is the planck's constant. The energy absorbed by one mole of the reacting molecules will then be given by

$$E = N_A \cdot h\nu = N_A \cdot hc / \lambda$$

where  $c$  is the velocity of light and  $\lambda$  its wavelength. The energy absorbed per mole of the reacting molecules is called one "Einstein". Since  $E$  is inversely proportional to  $\lambda$ ; therefore, shorter the wavelength, the greater is the energy absorbed.

Numerical Value of Einstein in different units:

**1) In CGS units:**

$$N_A = 6.022 \times 10^{23} \text{ mol}^{-1}$$

$$h = 6.626 \times 10^{-27} \text{ erg s}$$

$$c = 3 \times 10^{10} \text{ cm s}^{-1}$$

&  $\lambda$  is in cm

$$\text{Then., } E = \frac{(6.022 \times 10^{23} \text{ mol}^{-1}) (6.626 \times 10^{-27} \text{ erg s}) (3 \times 10^{10} \text{ cm s}^{-1})}{\lambda \text{ (cm)}}$$

$$= \frac{119.7 \times 10^6 \text{ erg mol}^{-1}}{\lambda \text{ (in cm)}}$$

$$= \frac{119.7 \times 10^6 \text{ cal mol}^{-1}}{4.184 \times 10^7 \lambda}$$

$$= \frac{2.86 \text{ cal mol}^{-1}}{\lambda \text{ (in cm)}}$$

$$= \frac{2.86}{\lambda \text{ (in } ^\circ\text{A)}} \times 10^8 \text{ cal mol}^{-1}$$

$$= \frac{2.86}{\lambda \text{ (in } ^\circ\text{A)}} \times 10^5 \text{ K cal mol}^{-1}$$

$$\lambda \text{ (in } ^\circ\text{A)}$$

**S. I. units:**

$$N_A = 6.022 \times 10^{23} \text{ mol}^{-1}, h = 6.626 \times 10^{-34} \text{ J s}$$

$$c = 3 \times 10^8 \text{ m s}^{-1}$$

$$\lambda = (\text{in m})$$

$$\text{then } E = \frac{11.97 \times 10^{-5} \text{ KJ mol}^{-1}}{\lambda (\text{in m})}$$

For a primary process, the number of molecules activated is equal to the number of quanta absorbed. The activated molecule may or may not react. On the other hand, an activated molecule may cause the reaction of many molecules through a chain mechanism. The law applies to the primary process in which the light is actually absorbed. The products of the primary process may take part in thermal or ‘dark’ reactions known as secondary reactions. Thus the total number of moles reacting for each Einstein of radiation absorbed may differ from unity.

To relate the number of quanta absorbed with the number of reacting molecules, a term called quantum efficiency or “quantum yield” ( $\phi$ ) has been introduced. It is expressed as:

$$\begin{aligned} \phi &= \frac{\text{No. of molecules reacting in a given time}}{\text{No. of quanta of light absorbed in the same time}} \\ &= \frac{\text{No. of moles reacting in a given time}}{\text{No. of Einstein's absorbed in the same time}} \\ &= \frac{\text{No. of moles reacting per sec.}}{\text{Quanta absorbed per sec.}} \\ &= \frac{\text{Rate of chemical reaction}}{\text{Quanta absorbed per sec.}} \end{aligned}$$

The quantum yield of any photochemical reaction is measured using an experimental set up as shown below.

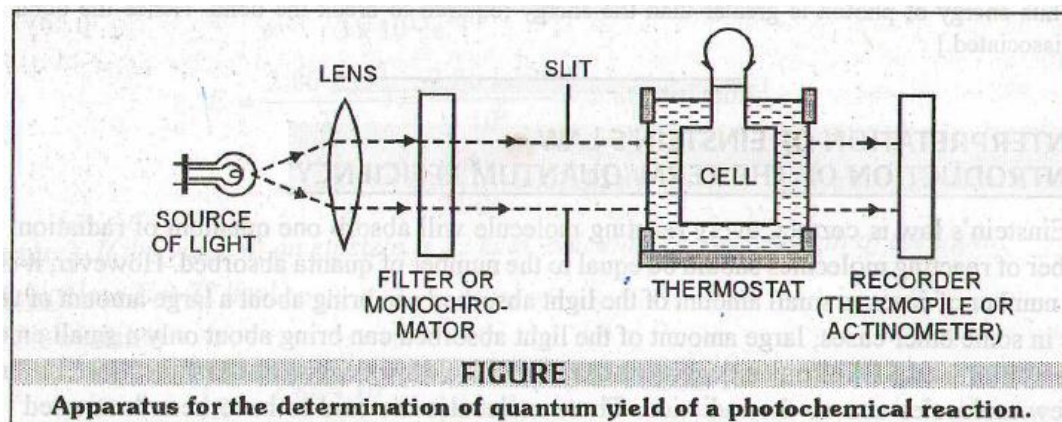

*Fig. Apparatus for the determination of quantum yield of a photochemical reaction.*

Various components of the apparatus are described as:

- (i) a light source which emits radiation of suitable intensity in the desired spectral range. The commonly used sources are filament lamps, carbon metal arcs and various gas discharge tubes.
- (ii) lens of suitable focal length.
- (iii) monochromator or filter which cuts off all radiations except the radiations of desired wavelength.
- (iv) slit to get a fine beam.
- (v) a cell placed in thermostat and containing the reaction mixture.

The cell is made of glass or quartz and has optically plane windows for the entrance and exit of light. Glass is used only if the wavelength of light used lies in the visible range. For radiations below 350 nm, the cell completely made of quartz is used. A detector or recorder which is usually a thermopile or an actinometer is used to measure the intensity of light radiations.



A thermopile is a set of thermocouples joined in series. Rods of two unlike metals (e.g, Ag and Bi) are joined alternately as shown in figure. One set of junctions of the thermocouple is blackened so as to absorb all the radiations and maintained at constant temperature by placing the system in a box. The radiations falling on the blackened metal strip are almost completely absorbed by it. As a result, this set of junctions becomes hot. The temperature difference of the hot and cold end produces a thermoelectric current in the circuit which is measured by connecting a milliammeter to the thermocouple. By calibrating the thermopile with radiations of known intensity, the intensity of the desired radiations can be measured.

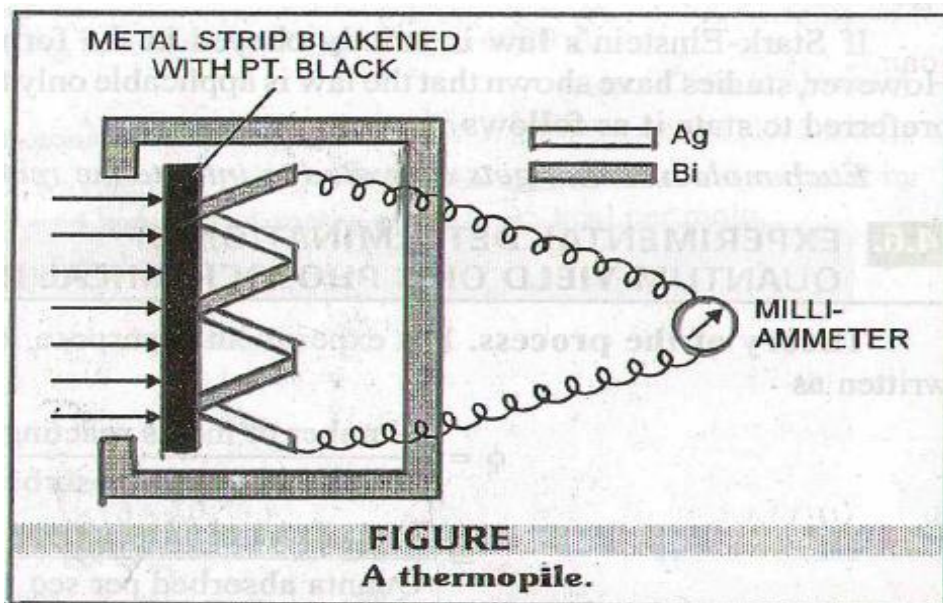

A chemical actinometer is a device in which gas mixture or solutions sensitive to light are used. The working of this device is based upon the fact that a definite amount of the radiation absorbed brings definite amount of a chemical reaction. The most commonly employed is the uranyl oxalate actinometer which consists of 0.05 M oxalic acid

and 0.01 M uranyl sulphate ( $\text{UO}_2 \text{SO}_4$ ) solutions in water. When exposed to light the following reaction takes place.

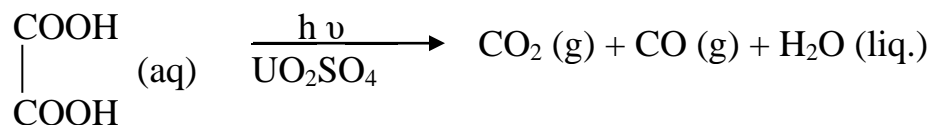

$\text{UO}_2 \text{SO}_4$  acts as a photosensitizer. The extent of reaction is measured by titrating the oxalic acid solution with  $\text{KMnO}_4$  solution. The actinometer is first calibrated against a thermopile. This actinometer can be used for measuring only the intensity of the radiation lying in the range 250 nm – 500 nm.

**Procedure:** The empty cell or the cell filled with solvent alone( in case of solutions) is placed in a thermostat. The monochromatic radiation is allowed to pass through the cell for a definite time. The reading is taken on the recorder. This gives the total energy incident at a given time. The cell is then filled with the reactants and again exposed to radiations for the definite time and the reading is taken again on the recorder. The difference between the two readings gives the total energy absorbed by the reactants in a given time. From this, the intensity of the radiation absorbed  $I_{\text{abs}}$  is calculated as follows:

$$I_{\text{abs}} = \frac{\text{Total energy absorbed}}{\text{Volume of the reaction mixture} \times \text{Time in sec.}}$$

The number of moles reacting in a given time (Rate of reaction) is determined by the usual analytical methods used in chemical kinetics.

### **High and low Quantum yield ( $\phi$ ):**

The various photochemical reactions can be divided into three categories:

- (i) Those in which the quantum yield is a small integer such as 1, 2, 3. Examples are combination between  $\text{SO}_2$  and  $\text{Cl}_2$  to give  $\text{SO}_2\text{Cl}_2$  ( $\phi = 1$ ), dissociation of  $\text{HI}$  and  $\text{HBr}$  ( $\phi = 2$ ), ozonization of  $\text{O}_2$  ( $\phi = 3$ ).
- (ii) Those in which the quantum yield is less than 1, examples are dissociation of  $\text{NH}_3$  ( $\phi = 0.25$ ) and combination between  $\text{H}_2$  &  $\text{Br}_2$  ( $\phi = 0.01$ )
- (iii) Those in which the quantum yield is very high, as for example combination of hydrogen and chlorine ( $\phi = 10^6$ ) and combination between  $\text{CO}$  and  $\text{Cl}_2$  ( $\phi = 10^3$ ).

M. Bodenstein proposed that photochemical processes involve two distinct processes.

**1. Primary Process:-** Primary processes are those processes in which quantum of energy ( $h\nu$ ) is absorbed by a molecule, resulting in the excitation of the molecule. Thus  $\text{A} + h\nu \longrightarrow \text{A}^*$

The molecule which absorbs light may get dissociated yielding excited state atoms or free radicals. The primary process may also involve loss of vibrational energy of excited molecules by collision with other molecules as well as by fluorescence and phosphorescence.

**2. Secondary Process:-** Those processes which involve the excited atoms, or free radicals produced in the primary steps or primary process.

### **Reasons for high quantum yield:**

1. The excited atoms or free radicals produced in the primary process initiate a series of chain reactions, as for example, in combination of  $\text{H}_2$  and  $\text{Cl}_2$  to give  $\text{HCl}$ , when the resulting quantum yields are of the order of  $10^6$  or more.

2. if the secondary reaction is exothermic, the heat of the reaction may activate molecules thereby causing them to react and thus result in a high quantum yield.

**Reason for low quantum yield:**

1. Excited molecules may get deactivated before they form products.
2. Collisions of excited molecules with non excited molecules may cause the former to lose energy.
3. The primary photochemical process may get reversed.
4. The dissociated fragments may recombine to form the original molecule.

The law of photochemical equivalence can be applied only to primary process in which each molecule capable of entering into chemical reaction absorbs one quantum of radiation. The secondary processes take place of themselves quite independent of the light radiation.

It may also be noted that if reactions in the secondary processes that are responsible for the formation of products are endothermic in nature, their rate of occurrence is extremely slow at ordinary temperatures. The reactions immediately following the primary process fall into this category and the quantum yield of such reactions increases with temperature rise. Kuhn found that the quantum yield of photochemical decomposition of ammonia increase by about 15% for every 100% rise in temperature.

The quantum yield is also affected by the intensity of light. For instance, when radiation from a highly intense source, such as laser,

falls on a molecule, the latter can even absorb two photons simultaneously. For such biphotonic and multiphotonic effects, the Stark-Einstein law needs to be modified.

## 1.6 Consequences of light Absorption: “The Jablonski Diagram”

According to Grotthus – Drapper law of photochemistry, also called the “principle of photochemical activation”, only that light which is absorbed by a system can bring about a chemical change. However, it is not essential that the light which is absorbed must bring about a photochemical change. The absorption of light may result in a number of other phenomena as well. For example, the light absorbed may cause only a decrease in the intensity of incident radiation and is governed by Lambert – Beer Law. The light absorbed may be re-emitted almost instantaneously and this phenomenon is known as fluorescence. The emission in fluorescence ceases with the removal of source of light. Sometimes the light absorbed is given out slowly and even long after the removal of the source of light. This phenomenon is known as phosphorescence. The phenomena of fluorescence and phosphorescence are best explained with the help of the Jablonski diagram.

In order to understand this diagram, it is necessary to define some terminology.

Most molecules have an even number of electrons and thus in the ground state, all the electrons are spin paired. The quantity  $2S + 1$ , where  $S$  is the total spin, is known as spin multiplicity of a state. When the spins are paired ( $\uparrow\downarrow$ ) as shown in figure below, the upward orientation of the spin is cancelled by the downward orientation.

So that  $S = 0$  as given under:

$$S_1 = \frac{1}{2}; \quad S_2 = -\frac{1}{2} \text{ so that } S = S_1 + S_2 = \frac{1}{2} - \frac{1}{2} = 0$$

Hence  $2S + 1 = 2(0) + 1 = 1$  and, therefore, the spin multiplicity of the molecule in this state is 1 & the molecule is said to be in the singlet ground state, denoted by  $S_0$ .

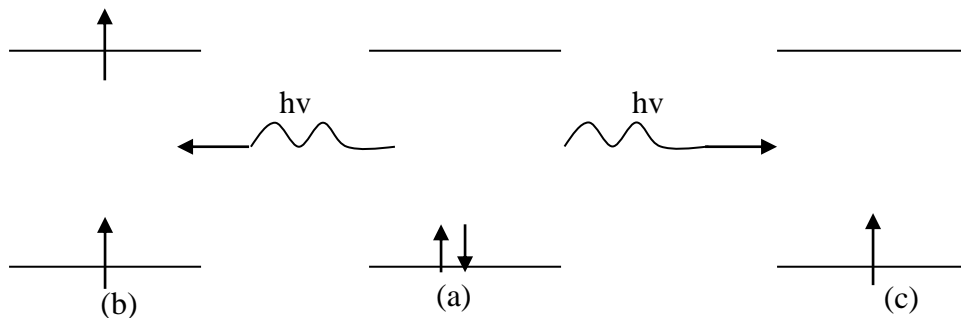

*Figure 1 : spin orientation on the absorption of a quantum of energy*

When by the absorption of a quantum of suitable energy “ $h\nu$ ”, one of the electrons goes to a higher energy level (excited state), the spin orientation of the two single electrons may be either parallel as shown in (b) of the figure 1 or anti-parallel as shown in (C).

Then if,  $S_1 = \frac{1}{2}$  &  $S_2 = \frac{1}{2}$  for parallel orientation

$$\begin{aligned}
 \text{Then spin multiplicity} &= 2S + 1 = 2(s_1 + s_2) + 1 \\
 &= 2 (\frac{1}{2} + \frac{1}{2}) + 1 \\
 &= 2 ( 1) + 1 \\
 &= 3
 \end{aligned}$$

The molecule is said to be in triplet excited state.

& if  $s_1 = \frac{1}{2}$  &  $s_2 = -\frac{1}{2}$  (antiparallel) then

$$\text{Spin multiplicity} = 2S + 1 = 2 (\frac{1}{2} - \frac{1}{2}) + 1 = 2 ( 0) + 1 = 1$$

The molecule is said to be in singlet excited state.

Since the electron can jump to any of the higher electronic states depending upon the energy of the quantum absorbed, we get a series of singlet excited states,  $S_n$  where  $n = 1, 2, 3, 4, \dots$  and a series of triplet excited states,  $T_n$  where  $n = 1, 2, 3, 4, \dots$ . Thus  $S_1, S_2, S_3$ , etc are known as the first excited singlet state, second excited singlet state, third excited singlet state etc. Similarly  $T_1, T_2, T_3$  etc are called the first excited triplet state, second excited triplet state, third excited triplet state etc. It may be noted that  $S_0$  is the symbol that denotes the ground singlet state.

It is proved in quantum mechanics that a singlet excited state has higher energy than the corresponding triplet excited state. Accordingly the energy is as follows:

$$E_{S1} > E_{T1}; E_{S2} > E_{T2}; E_{S3} > E_{T3} \dots\dots\dots$$

On absorption of a quantum of energy, the electron of the absorbing molecule may jump from  $S_0$  to  $S_1, S_2, S_3 \dots\dots\dots$  Singlet excited states depending upon the energy of the quantum absorbed, as shown in the Jablonski diagram (Fig 2).

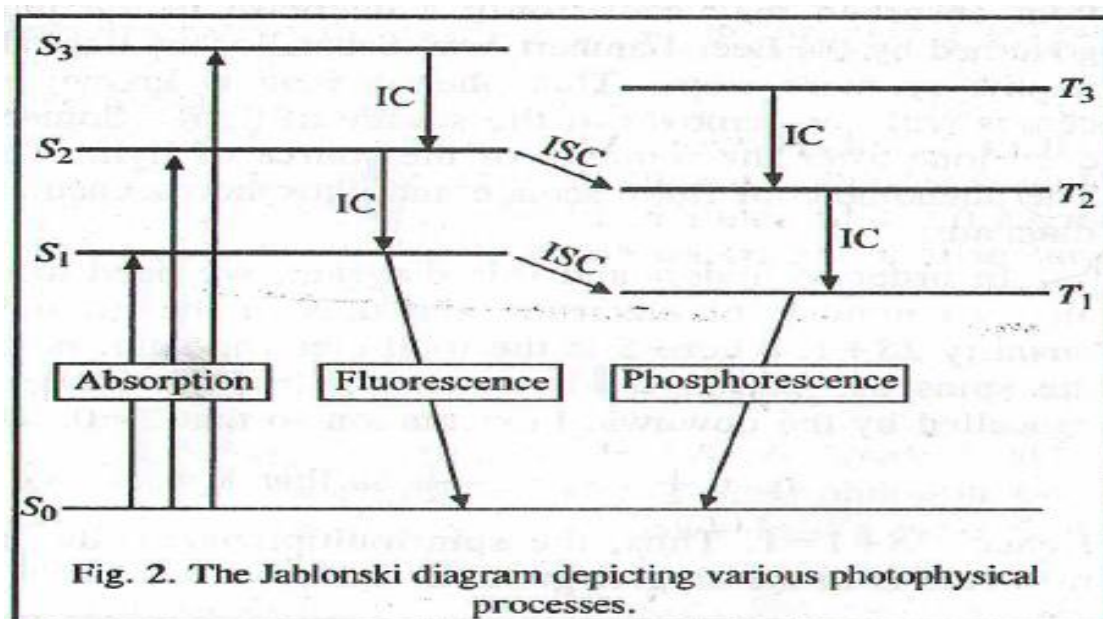

Fig. 2. The Jablonski diagram depicting various photophysical processes.



**Fig. 2: Jablonski diagram depicting various photochemical processes**

For each singlet state (excited) there is a corresponding triplet excited state. The molecule in singlet or triplet excited state is said to be activated. Thus;



where  $A_0$  is the molecule in the ground state and  $A^*$  is the molecule in the excited state. The activated molecule returns to the ground state by dissipating its energy through the following types of processes:

**1) Non Radiative Transitions:** These transitions involve the return of the activated molecule from the higher activated states ( $S_3$ ,  $S_2$  or  $T_3$ ,  $T_2$ ) to the first excited state ( $S_1$  or  $T_1$ ). These transitions do not involve the emission of any radiations and are thus referred to as non radiative or radiationless transitions. The energy of the activated molecule is dissipated in the form of heat through molecular collisions. The process is called internal conversion (IC) and occurs in less than about  $10^{-11}$ s.

The molecule may also lose energy by another process called inter system crossing (ISC). This process involves transitions between states of different spins i.e. different multiplicity, as for example, from  $S_2$  to  $T_2$ , or  $S_1$  to  $T_1$ . These transitions are also non-radiative or radiationless. Spectroscopically, such transitions are forbidden. However, they do occur though at relatively slow rates.

**2) Radiative Transitions:** These transitions involve the return of the activated molecule from the singlet excited state  $S_1$  and triplet excited state  $T_1$  to  $S_0$ . Such transitions are accompanied by the emission of radiation. Spectroscopically, the transition from  $S_1$  to  $S_0$  is

allowed transition and occurs in about  $10^{-8}$  s. The emission of radiation in this transition is called fluorescence.

The transition from the triplet excited state  $T_1$  to the ground singlet state  $S_0$  is slow since it is a forbidden transition. The emission of radiation in this transition is called phosphorescence. The life time of phosphorescence are much longer being of the order of  $10^{-3}$  s or more, since the transition involves spin inversion which needs time for its occurrence.

Both fluorescent and phosphorescent radiations are of shorter frequencies than the exciting radiation. This is because, some part of the absorbed energy by the molecules is dissipated in the form of heat during non-radiative transition.

**3) Photochemical Reaction:** The activated molecule may also lose energy by undergoing chemical change. The molecule which undergoes chemical reaction is the one which is previously in a triplet state (excited) as it gets ample time to undergo the change. The molecule, however, gets no chance to react chemically if it is in singlet excited state as it returns quickly to the ground state.

### **1.7 Energy transfer in photochemical reactions : Photosensitization & Quenching Reactions.**

Some chemical reactions take place not by the absorption of light by one of the reactants but by a third substance which transfers the absorbed energy to the reactants. The third substance which itself does not undergo any change is called the photosensitizer and the process is known as photosensitization. Among the photosensitizers commonly

used are mercury, cadmium and zinc as atomic sensitizers and the molecular photosensitizers such as benzophenone and  $\text{SO}_2$ .

Consider a general donor-acceptor system in which only the donor D i.e. the sensitizer, absorbs the incident quantum of energy and the triplet state of the donor is higher in energy than the triplet state of the acceptor A i.e. the reactant. Absorption of the photon produces the singlet excited state of the donor,  $^1\text{D}$  which via inter-system crossing (ISC) gives the triplet excited state of the donor  $^3\text{D}$ . This triplet excited state of the donor then collides with the acceptor producing the triplet excited state of the acceptor  $^3\text{A}$  and the ground state of the donor. If  $^3\text{A}$  gives the desired products, the mechanism is called photosensitization. If, however, the products of interest result from  $^3\text{D}$ , then A is called the quencher and the process is known as quenching.

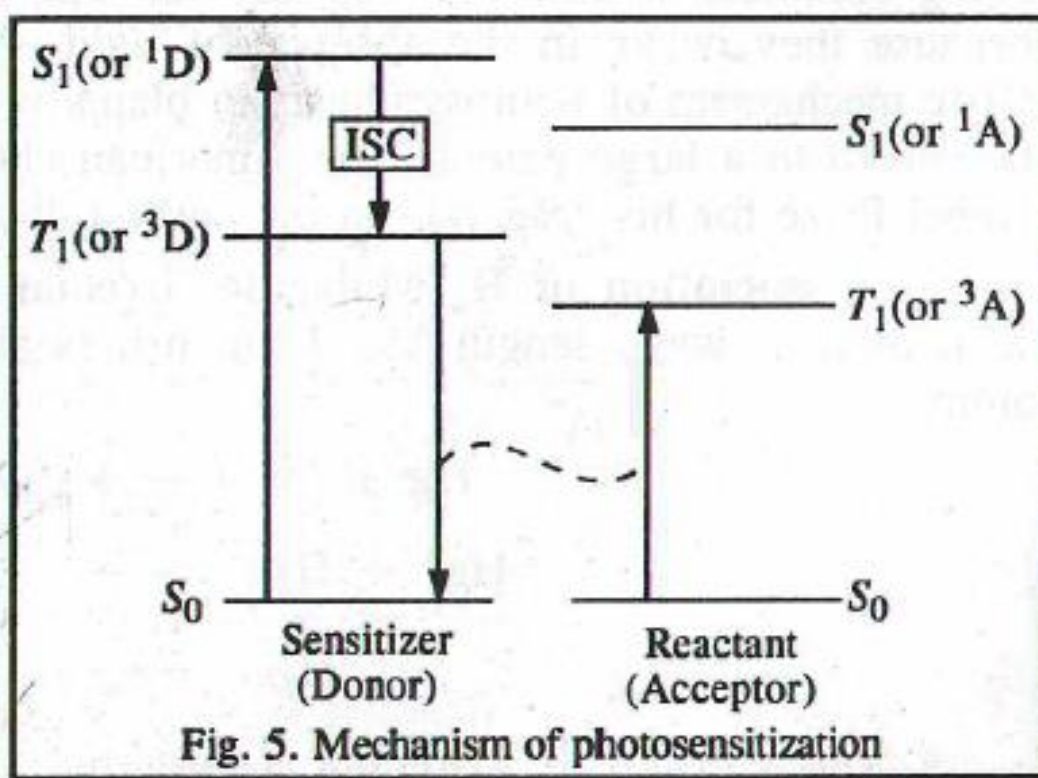

The reactions depicting photosensitization and quenching may be represented as follows:

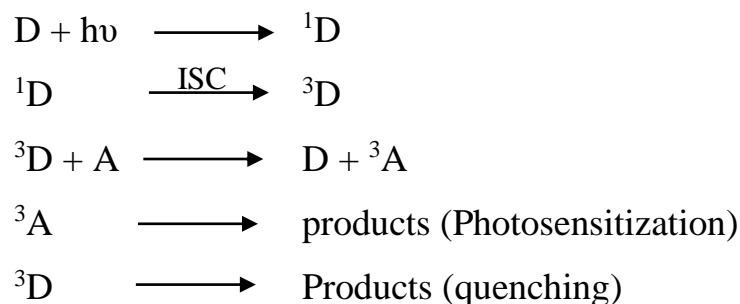

It may be noted that the triplet excited state of the sensitizer must be higher in energy than the triplet excited state of the acceptor (Reactant) so that the energy available is enough to raise the reactant molecule to its triplet excited state. Photosensitization was discovered by Frank and Cario in 1922.

**Examples of Photosensitized reactions:**

1. The most important example of Photosensitization is the photosynthesis of carbohydrates in plants from CO<sub>2</sub> and H<sub>2</sub>O in which chlorophyll, the green colouring matter of plants, acts as a photosensitizer. Neither CO<sub>2</sub> nor H<sub>2</sub>O absorbs any radiation in the visible range but chlorophyll does absorb in the visible range and then transfers to CO<sub>2</sub> + H<sub>2</sub>O molecules which then react to form carbohydrate.
2. **Dissociation of H<sub>2</sub> molecule:** Irradiation of a mixture of hydrogen gas and mercury vapour with light of wavelength 253.7 nm brings about dissociation of H<sub>2</sub> in hydrogen atoms.

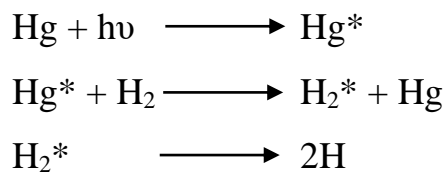

Here Hg acts as photosensitizer

3. **Decomposition of diazomethane:** Diazomethane undergoes decomposition when exposed to radiation of 320 nm in the presence of benzophenone which acts as a photosensitizer.

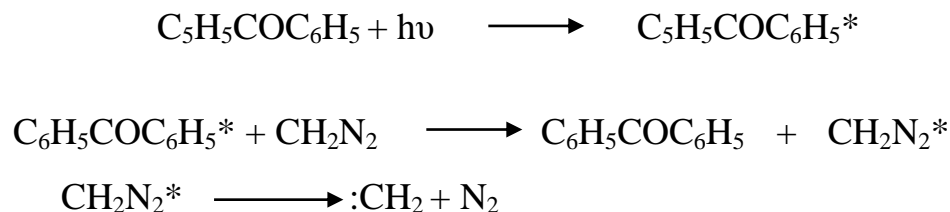

4. **Dissociation of ethylene:**

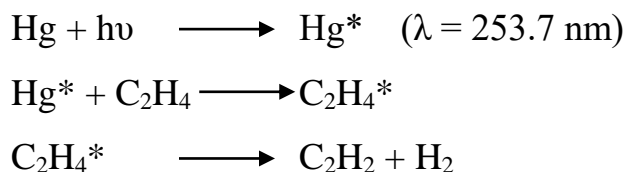

### **1.8 Quenching of Fluorescence : Stern – Volmer equation:**

Fluorescence occurs when certain molecules absorb energy (uv/visible) i.e. they are activated and then quickly re-emit energy. If the excited molecules are deactivated and the fluorescence stops, the phenomenon is called “quenching”

The substances which are responsible for stopping the fluorescence are called “quenchers” and are represented by “Q”.

Quenching may occur in either of the two ways:

1. When the activated molecule undergoes a change from a singlet excited state to a triplet excited state. This is called “Internal quenching”.

2. When the activated molecules collide with other molecules / quenchers which are the externally added species and transfer their energy to those molecules. This is called external quenching.

Thus, the various steps from activation to deactivation may be represented as follows:

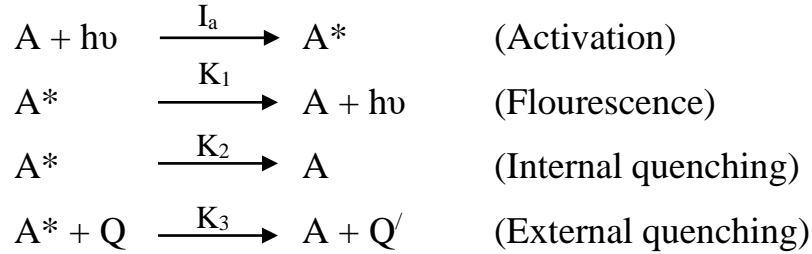

Applying steady state approximation (s.s.a) to the concentration of  $A^*$ , we have

$$\begin{aligned}
 \Rightarrow \quad \frac{d[A^*]}{dt} &= 0 \\
 \Rightarrow \quad I_a - K_1 [A^*] - K_2 [A^*] - K_3 [A^*] [Q] &= 0 \\
 \Rightarrow \quad I_a &= K_1 [A^*] + K_2 [A^*] + K_3 [A^*] [Q] \\
 \Rightarrow \quad I_a &= [A^*] \{ K_1 + K_2 + K_3 [Q] \} \dots\dots\dots (1)
 \end{aligned}$$

Where  $I_a$  represents the intensity of light absorbed.

If,  $I_f$ , represents the intensity of fluorescence, then in the presence of quencher, the quantum yield of flourescence will be given by

$$\begin{aligned}
 \phi_f \text{ or } \phi_Q &= I_f / I_a \\
 &= \frac{K_1 [A^*]}{[A^*] \{ (K_1 + K_2) + K_3 [Q] \}} \\
 \phi_Q &= \frac{K_1}{\{ (K_1 + K_2) + K_3 [Q] \}} \dots\dots\dots (2)
 \end{aligned}$$

In the absence of quencher i.e. when  $[Q] = 0$ , the quantum yield represented by  $\phi_0$  will become

$$\phi_0 = \frac{K_1}{(K_1 + K_2)} \dots\dots\dots(3)$$

The ratio of the two quantum yields will be

$$\begin{aligned} \frac{\phi_0}{\phi_Q} &= \frac{K_1}{K_1 + K_2} \times \frac{(K_1 + K_2) + K_3[Q]}{K_1} \\ &= \frac{(K_1 + K_2) + K_3[Q]}{(K_1 + K_2)} \\ &= 1 + \frac{K_3}{(K_1 + K_2)} \cdot [Q] \dots\dots\dots(4) \end{aligned}$$

Putting  $\frac{1}{(K_1 + K_2)} = \tau$ , called life time of A\* in the absence of quencher equation (4) may be written as:

$$\frac{\phi_0}{\phi_Q} = 1 + K_3 \cdot \tau [Q] \dots\dots\dots (5)$$

or

$$\frac{\phi_0}{\phi_Q} = 1 + K_{SV} \cdot [Q] \dots\dots\dots(6)$$

This equation is known as Stern-Volmer equation. And the constant  $K_{SV}$  is called Stern-Volmer constant. This equation shows that  $\phi_0 / \phi_Q$  varies linearly with  $[Q]$ . the slope of the line will be  $K_{SV}$  i.e.  $K_3 \tau$ , from which the value of  $\tau$  can be calculated.

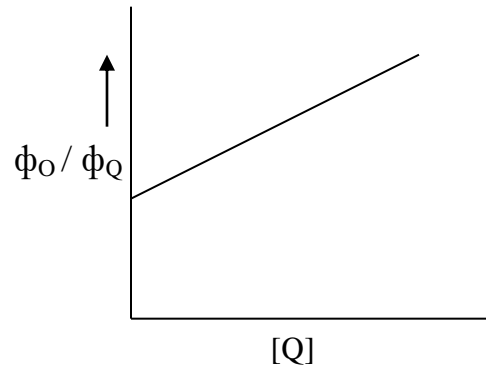

## 1.9 Kinetics of some important photochemical reaction:

### 1). Reaction between H<sub>2</sub> and Br<sub>2</sub>

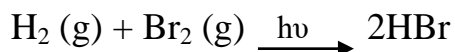

The mechanism of this reaction is the same as that of the thermal reaction studied by Bodenstein and Lind; the only difference being that the first step in the photochemical reaction is the dissociation of Br<sub>2</sub> into Br atoms by the absorption of a quantum of energy  $h\nu$ .

The above reaction proceeds according to the empirical equation

$$\frac{d[\text{HBr}]}{dt} = \frac{K' [\text{H}_2] \cdot I_a}{1 + m' \{ \text{HBr} \} / [\text{Br}_2]} \dots\dots\dots(1)$$

Where  $K'$  and  $m'$  are the constants and  $I_a$  is the intensity of radiation absorbed.

The following mechanism has been suggested for the reaction.

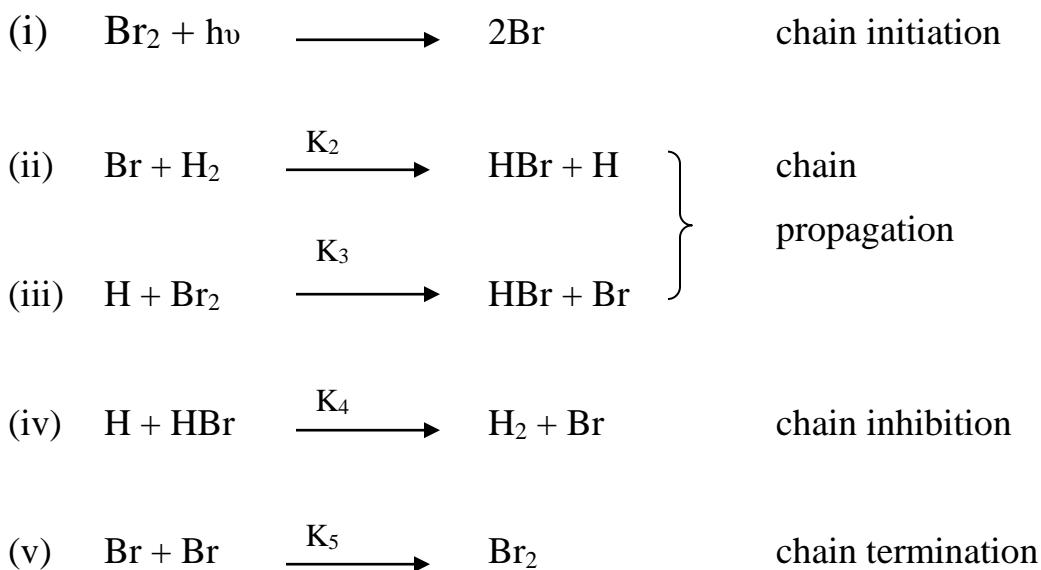



The above scheme has the characteristic features of a chain reaction, namely, the initiation and termination steps and the pair of chain propagating steps. It has also an additional reaction (iv) which accounts for the inhibition of the reaction by the product HBr. Both Br<sub>2</sub> and HBr compete with one another for H atoms is due to the fact that the reactions have same activation energy and it is for this reason that [HBr] / [Br<sub>2</sub>] appears in the denominator of equation 1.

The steady state hypothesis must be applied to both the intermediates (short lived) because their net rate of formation is zero. The steady state equation for H is

$$\frac{d[H]}{dt} = K_2 [Br] [H_2] - K_3 [H] [Br_2] - K_4 [H] [HBr] = 0 \dots\dots(2)$$

Also steady state equation for Br is

$$d [Br]/dt = 2 I_a - K_2[Br] [H_2] + K_3 [H] [Br_2] + K_4 [H] [HBr] - 2K_5 [Br]^2 = 0 \dots\dots\dots(3)$$

Adding eq. (2) and eq. (3) we get

$$2I_a - 2 K_5 [Br]^2 = 0$$

$$\Rightarrow 2K_5 [Br]^2 = 2 I_a$$

$$\Rightarrow [Br] = I_a^{1/2} / K_5^{1/2} \dots\dots\dots(4)$$

This is the equilibrium concentration of Br atoms.

From equation (2) we have

$$K_2 [Br] [H_2] = K_3 [H] [Br_2] + K_4 [H] [HBr]$$

$$\Rightarrow K_2 [Br] [H_2] = [H] \{K_3[Br_2] + K_4[HBr]\}$$

$$\Rightarrow [H] = \frac{K_2 [Br] [H_2]}{K_3 [Br_2] + K_4 [HBr]} \dots\dots\dots(5)$$

The rate of formation of HBr is

$$\frac{d[HBr]}{dt} = K_2 [Br] [H_2] + K_3 [H] [Br_2] - K_4 [H] [HBr]$$

$$\begin{aligned}
&= K_2 [\text{Br}] [\text{H}_2] + [\text{H}] \{K_3 [\text{Br}_2] - K_4 [\text{HBr}]\} \\
&= K_2 [\text{Br}] [\text{H}_2] + \frac{K_2 [\text{Br}] [\text{H}_2]}{K_3 [\text{Br}_2] + K_4 [\text{HBr}]} \{K_3 [\text{Br}_2] - K_4 [\text{HBr}]\} \\
&= K_2 [\text{Br}] [\text{H}_2] \left\{ 1 + \frac{(K_3 [\text{Br}_2] - K_4 [\text{HBr}])}{(K_3 [\text{Br}_2] + K_4 [\text{HBr}])} \right\} \\
&= K_2 [\text{Br}] [\text{H}_2] \left\{ \frac{K_2 [\text{Br}_2] + K_3 [\text{HBr}] + K_2 [\text{Br}_2] - K_3 [\text{HBr}]}{K_3 [\text{Br}_2] + K_4 [\text{HBr}]} \right\} \\
&= \frac{K_2 [\text{Br}] [\text{H}_2] \cdot 2K_3 [\text{Br}_2]}{K_3 [\text{Br}_2] + K_4 [\text{HBr}]} \\
&= \frac{2 K_2 K_3 \cdot [\text{Br}_2] \cdot [\text{Br}] [\text{H}_2]}{K_3 [\text{Br}_2] + K_4 [\text{HBr}]}
\end{aligned}$$

Dividing numerator and denominator by  $K_3 [\text{Br}_2]$  we get

$$\frac{d[\text{HBr}]}{dt} = \frac{2 K_2 [\text{H}_2] [\text{Br}]}{1 + \frac{K_4 [\text{HBr}]}{K_3 [\text{Br}_2]}}$$

Substituting the value of  $[\text{Br}]$  from eq (4) in eq. (5) we get

$$\frac{d[\text{HBr}]/dt}{dt} = \frac{2 (K_1/K_4^{1/2}) [\text{H}_2] \cdot I_a^{1/2}}{1 + (K_3/K_2) \cdot [\text{HBr}] / [\text{Br}_2]}$$

$$\frac{d[\text{HBr}]}{dt} = \frac{K' [\text{H}_2] \cdot I_a^{1/2}}{1 + m' \{ [\text{HBr}]/[\text{Br}_2] \}} \dots\dots\dots (6)$$

$$K' = \frac{2 K_2}{\sqrt{K_5}} \quad \text{and} \quad m' = (K_4 / K_3)$$

Equation (6) indicates that the rate of formation of HBr depends upon the square root of intensity of light absorbed. The quantum yield ( $\phi$ ) of this reaction is very low, being about 0.01 at ordinary

temperature. This is due to the reason that reaction (ii) is highly endothermic and, therefore, takes place slowly at ordinary temperatures and thus most of the Br atoms formed in the chain initiation step recombine to give back bromine molecules. Hence the other reactions that depend on the rate of occurrence of reaction (ii) occur very slowly. The quantum yield of the photochemical reaction, however, increases with increase in temperature.

### **Photochemical reaction between H<sub>2</sub> and Cl<sub>2</sub>:**

The photochemical reaction between hydrogen and chlorine show some resemblance to the hydrogen – bromine reaction, but the mechanisms are slightly complicated. Oxygen, even in minute amounts has a profound effect on the rate and early kinetic studies showed important discrepancies because different amounts of oxygen were present in the reaction system as an impurity. When oxygen present as impurity is appreciable in concentration; the rate is inversely proportional to its concentration and when the gases are purified from oxygen, the rate becomes extremely high. In the absence of oxygen, the rate becomes extremely high. In the absence of oxygen, the rate is independent of the chlorine pressure. Thus the rate expression for the photochemical reaction between H<sub>2</sub> and Cl<sub>2</sub> shall have to be discussed in absence and presence of oxygen separately.

**1. In absence of Oxygen:** The following mechanism has been proposed for the reaction:

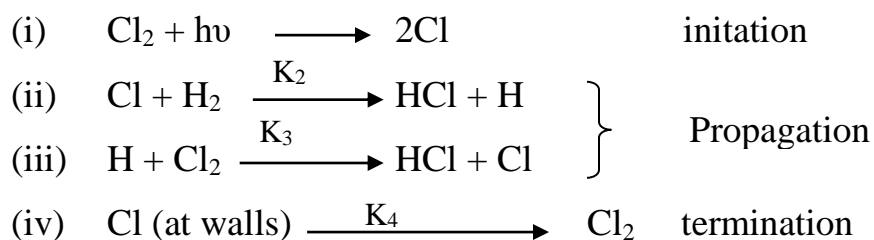



### Derivation of the rate law:

The rate of formation of HCl is given as:

$$\frac{d[\text{HCl}]}{dt} = K_2 [\text{Cl}] [\text{H}_2] + K_3 [\text{H}] [\text{Cl}_2] \quad \dots\dots\dots (1)$$

Since H and Cl are reactive intermediates, therefore, applying steady – state treatment we have for H atoms

$$\frac{d[\text{H}]}{dt} = K_2 [\text{Cl}] [\text{H}_2] - K_3 [\text{H}] [\text{Cl}_2] = 0 \quad \dots\dots\dots(2)$$

Also

$$\frac{d[\text{Cl}]}{dt} = 2 I_a - K_2 [\text{Cl}] [\text{H}_2] + K_3 [\text{H}] [\text{Cl}_2] - K_4 [\text{Cl}] = 0 \quad \dots\dots(3)$$

Adding eq. (2) and eq. (3) we get

$$\begin{aligned} 2I_a - K_4 [\text{Cl}] &= 0 \\ \Rightarrow [\text{Cl}] &= 2I_a / K_4 \quad \dots\dots\dots(4) \end{aligned}$$

Also from eq. (2) we have

$$\begin{aligned} K_2 [\text{Cl}] [\text{H}_2] &= K_3 [\text{H}] [\text{Cl}_2] \\ \Rightarrow [\text{H}] &= \frac{K_2 [\text{Cl}] [\text{H}_2]}{K_3 [\text{Cl}_2]} \quad \dots\dots\dots(5) \end{aligned}$$

The activation energy for reaction (iii) i.e.,  $\text{Cl} + \text{H}_2 \longrightarrow \text{HCl}$  is 6.0 K cal whileas for reaction (ii) i.e.,  $\text{H} + \text{Cl}_2 \longrightarrow \text{HCl}$  , it is 2-3.6 Kcal, hence eq. 1 becomes as

$$d[\text{HCl}]/dt = K_3[\text{H}][\text{Cl}_2]$$

Substituting the value of [H] from eq. (5) in eq. (1) we get

$$\begin{aligned} d[\text{HCl}]/dt &= \left\{ \frac{K_3[\text{Cl}_2] \cdot K_2[\text{H}_2]}{K_3[\text{Cl}_2]} \right\} [\text{Cl}] \\ &= K_2 [\text{Cl}][\text{H}_2] \\ &= 2 K_2 [\text{H}_2] \cdot I_a / K_4 \\ &= (2K_2/K_4) I_a [\text{H}_2] \end{aligned}$$

Thus .,

$$d[\text{HCl}]/dt = K' I_a \cdot [\text{H}_2] \quad \dots\dots\dots (6)$$

Thus the rate is directly proportional to the intensity of light absorbed,  $I_a$  and to the first power of hydrogen concentration. Eq. (6) is in perfect agreement with experimental / observed rate expression. The quantum, yield of this reaction is approximately  $10^6$ . The high quantum yield of the reaction is based on the fact that reaction (ii) is exothermic and, therefore, takes place very easily.

**2) In presence of Oxygen:-**

The following mechanism has been proposed for the reaction in presence of oxygen.

- (i)  $\text{Cl}_2 + h\nu \longrightarrow 2\text{Cl}$
- (ii)  $\text{Cl} + \text{H}_2 \xrightarrow{K_2} \text{HCl} + \text{H}$
- (iii)  $\text{H} + \text{Cl}_2 \xrightarrow{K_3} \text{HCl} + \text{Cl}$
- (iv)  $\text{H} + \text{O}_2 \xrightarrow{K_4} \text{HO}_2$
- (v)  $\text{Cl} + \text{O}_2 \xrightarrow{K_5} \text{ClO}_2$
- (vi)  $\text{Cl} + \text{X} \xrightarrow{K_6} \text{ClX}$

Here X is any substance that can remove chlorine atoms. The chain ending step  $\text{Cl} + \text{Cl} \rightarrow \text{Cl}_2$  is not included in this scheme, since under ordinary conditions Cl atoms are removed more effectively by

reactions (v) and (vi). The species HO<sub>2</sub> that is formed in reaction (iv) is unstable and is eventually converted into water and oxygen.

Applying steady state treatment to Cl atoms we have

$$\frac{d[\text{Cl}]}{dt} = 2 I_a - K_2[\text{Cl}] [\text{H}_2] + K_3 [\text{H}] [\text{Cl}_2] - K_5 [\text{Cl}] [\text{O}_2] - K_6 [\text{Cl}][\text{X}] = 0$$

-----(1)

The steady state treatment for H atoms is

$$\frac{d[H]}{dt} = K_2[Cl][H_2] - K_3[H][Cl_2] - K_4[H][O_2] = 0 \text{ -----(2)}$$

From which it follows that

$$[Cl] = \frac{K_3[H][Cl_2] + K_4[H][O_2]}{K_2[H_2]}$$

Rearranging eq. (1) we get

$$2I_a + K_3[H][Cl_2] = \{K_2[H_2] + K_5[O_2] + K_6[X]\}[Cl]$$

$$\Rightarrow 2I_a + K_3[H][Cl_2] = \frac{K_3[H][Cl_2] + K_4[H][O_2]}{K_2[H_2]} \cdot \{K_2[H_2] + K_5[O_2] + K_6[X]\}$$

$$\Rightarrow 2I_a \cdot K_2[H_2] + K_2K_3[H][H_2][Cl_2] = [H] \left\{ (K_3[Cl_2] + K_4[O_2]) \right. \\ \left. (K_2[H_2] + K_5[O_2] + K_6[X]) \right\}$$

$$\Rightarrow 2I_a \cdot K_2[H_2] + K_2K_3[H][H_2][Cl_2] = \\ [H] \left\{ K_2K_3[H_2][Cl_2] + K_3K_5[Cl_2][O_2] + K_3K_6[Cl_2][X] + \right. \\ \left. K_2K_4[O_2][H_2] + K_4K_5[O_2]^2 + K_4K_6[O_2][X] \right\}$$

Neglecting the small term containing  $[O_2]^2$  we get

$$2I_a \cdot K_2[H_2] = [H] \left\{ K_3K_5[Cl_2][O_2] + K_3K_6[Cl_2][X] + \right. \\ \left. K_2K_4[O_2][H_2] + K_4K_6[O_2][X] \right\}$$

$$\Rightarrow [H] = \frac{2K_2 I_a [H_2]}{K_3K_6 [Cl_2][X] + [O_2] \left\{ K_3K_5[Cl_2] + K_2K_4 [H_2] + K_4K_6 [X] \right\}} \\ \text{..... (4)}$$

The rate of formation of HCl is given as

$$\frac{d[HCl]}{dt} = K_2[Cl][H_2] + K_3[H][Cl_2] \text{ ..... (5)}$$



The activation energy for reaction (iii) i.e.,  $\text{Cl} + \text{H}_2 \longrightarrow \text{HCl}$  is 6.0 K cal while as for reaction (ii) i.e.,  $\text{H} + \text{Cl}_2 \longrightarrow \text{HCl}$ , it is 2-3.6 Kcal, hence eq. 5 becomes as

$$d[\text{HCl}]/dt = K_3[\text{H}][\text{Cl}_2]$$

$$\begin{aligned} \frac{d[\text{HCl}]}{dt} &= [\text{H}] \{ K_3 [\text{Cl}_2] \} \\ &= \frac{2( K_3/ K_4) I_a [\text{H}_2] \cdot [\text{Cl}_2]}{(K_3K_6/K_2K_4) [\text{Cl}_2] [\text{X}] + [\text{O}_2] \left\{ \frac{K_3K_5}{K_2K_4} [\text{Cl}_2] + \right.} \\ &\quad \left. + ( K_2 K_4/K_2K_4) [\text{H}_2] + ( K_4 K_6/K_2K_4) [\text{X}] \right\}} \\ &= \frac{2( K_3/K_4 ) \cdot I_a \cdot [\text{H}_2] [\text{Cl}_2]}{\frac{K_3K_6}{K_2K_4} [\text{Cl}_2] [\text{X}] + [\text{O}_2] \left\{ \frac{K_3K_5}{K_2K_4} [\text{Cl}_2] + [\text{H}_2] + \frac{K_6}{K_2} [\text{X}] \right\}} \end{aligned}$$

Apart from the last term; the above eq. becomes

$$= \frac{K \cdot I_a [\text{H}_2] [\text{Cl}_2]}{m [\text{Cl}_2] + [\text{O}_2] \{ [\text{H}_2] + n [\text{Cl}_2] \}}$$

where  $\left( \frac{2K_3}{K_4} \right) = K; \quad \left( \frac{K_3K_6}{K_2K_4} \right) [\text{X}] = m$

&  $\left( \frac{K_3K_5}{K_2K_4} \right) = n$

Thus  $\frac{d[\text{HCl}]}{dt} = \frac{K I_a [\text{H}_2] [\text{Cl}_2]}{m [\text{Cl}_2] + [\text{O}_2] \{ [\text{H}_2] + n [\text{Cl}_2] \}} \dots\dots\dots (7)$

The above rate law is essentially in agreement with the experimental rate equation as given by Bodenstein & Unger.

**Photochemical decomposition of Hydrogen Iodide:**

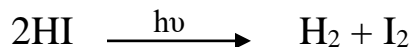

Warburg proposed the following mechanism for the reaction

- (i)  $\text{HI} + h\nu \longrightarrow \text{H} + \text{I}$
- (ii)  $\text{H} + \text{HI} \xrightarrow{K_2} \text{H}_2 + \text{I}$
- (iii)  $\text{I} + \text{I} \xrightarrow{K_3} \text{I}_2$

The rate law for the decomposition of HI is given by

$$-\frac{d[\text{HI}]}{dt} = I_a + K_2 [\text{H}] [\text{HI}] \dots\dots\dots(1)$$

Applying steady state approximation to [H]

we get 
$$\frac{d[\text{H}]}{dt} = I_a - K_2 [\text{H}] [\text{HI}] = 0 \dots\dots\dots(2)$$

$$\Rightarrow K_2 [\text{H}] [\text{HI}] = I_a \dots\dots\dots(3)$$

Thus 
$$-\frac{d[\text{HI}]}{dt} = 2I_a \dots\dots\dots(4)$$

The quantum yield of the reaction

$$\phi = \frac{\text{Rate of disappearance of HI}}{I_a} = \frac{2I_a}{I_a} = 2$$

The quantum yield is an agreement with the observed value.

It has been observed that as the reaction proceeds, the value of  $\phi$  decreases. This is due to the fact that as Iodine accumulates the thermal reaction.



is included in the mechanism, then the rate law becomes

$$-\frac{d[\text{HI}]}{dt} = I_a \left\{ 1 + \frac{1}{1 + \{(K_4[\text{I}_2] / K_2 [\text{HI}])\}} \right\} .$$

As the reaction proceeds,  $\text{I}_2$  increases and hence the quantum yield decreases.